

MTX Series

Direct print resistance board

Special surface treatment (Long sliding life)

Small size motor

Thinner mounted devices are possible.

Photo in preparation

Model number

MTX-1100 - **B** **10K** - **M7V**
*1 *3 *4 *5

*1	Product number and Travel	MTX-1100: 100mm MTX-6100: 60mm
*2	Output law	B: Linear taper
*3	Total resistance	10K: 10kohm 5K: 5kohm
*4	DC Motor type	M7V: Iron cored motor

Circuit method (Unbalanced)



Potentiometer circuit

Output Law

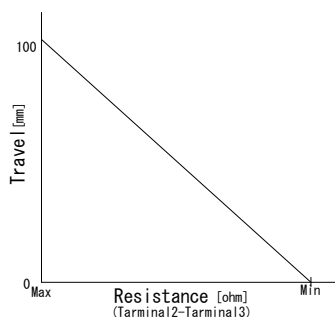

Linear taper

Electrical specifications

	MTX-****-B
Circuit (Unbalanced)	1
Total resistance (1-3)	5k, 10kohm
Total resistance tolerance	±20%
Taper	Linear taper (Potentiometer circuit)
Linearity	±5% (Linear taper)
Residual resistance	50ohm or less (Linear taper)
Touch sense track Contact resistance	30ohm or less
Voltage proof	1 Min. at AC100V
Insulation resistance	50Mohm or more at DC100V
Max rating	DC20V (0.1W)
Sliding noise level	47mV or less (by JIS C 6443)
Sliding life	100,000 Cycles Min. (18cycles/min, Sliding noise level: Less than 100mV)
Drive motor data	Iron cored motor — Input voltage: DC3V - 7V (Nominal DC7V), Stall current: 0.68A or less (DC7V)

Mechanical specifications

	MTX-1100	MTX-6100
Stroke length	100mm±0.5mm	60mm±0.5mm
Operating force	0.1~0.4N	
Strength of Nut-Attached	100Ncm	
Attached Parts	M3 screw (Length: Panel thickness + 3~5mm)	
Stopper strength	30N	
Push-pull strength	30N	
Alignment to the center	±0.5mm (State not to pressure control-bar, Measurement position: Mounting surface)	

General specifications

	MTX Series
Temperature range	0 to +50 degrees C (Operating), -10 to +60 degrees C (Storage)
Relative humidity	80%RH (No condensation)

Note

- * Solder heat resistance: 300deg C max, 3sec max, 2 times. (Manual soldering only)
- * Please take care during soldering that the smoke from the solder does not flow inside a fader.
- * If the flux sticks to a resistor board, it may cause a trouble with the fader.
- * Move to one end in Control-bar on the occasion of knob wearing, and can break into it slowly.
- * It is highly recommended that the fault tolerant system is to be set up in the big situation like the live broadcast.

Dimensions - MTX-1100

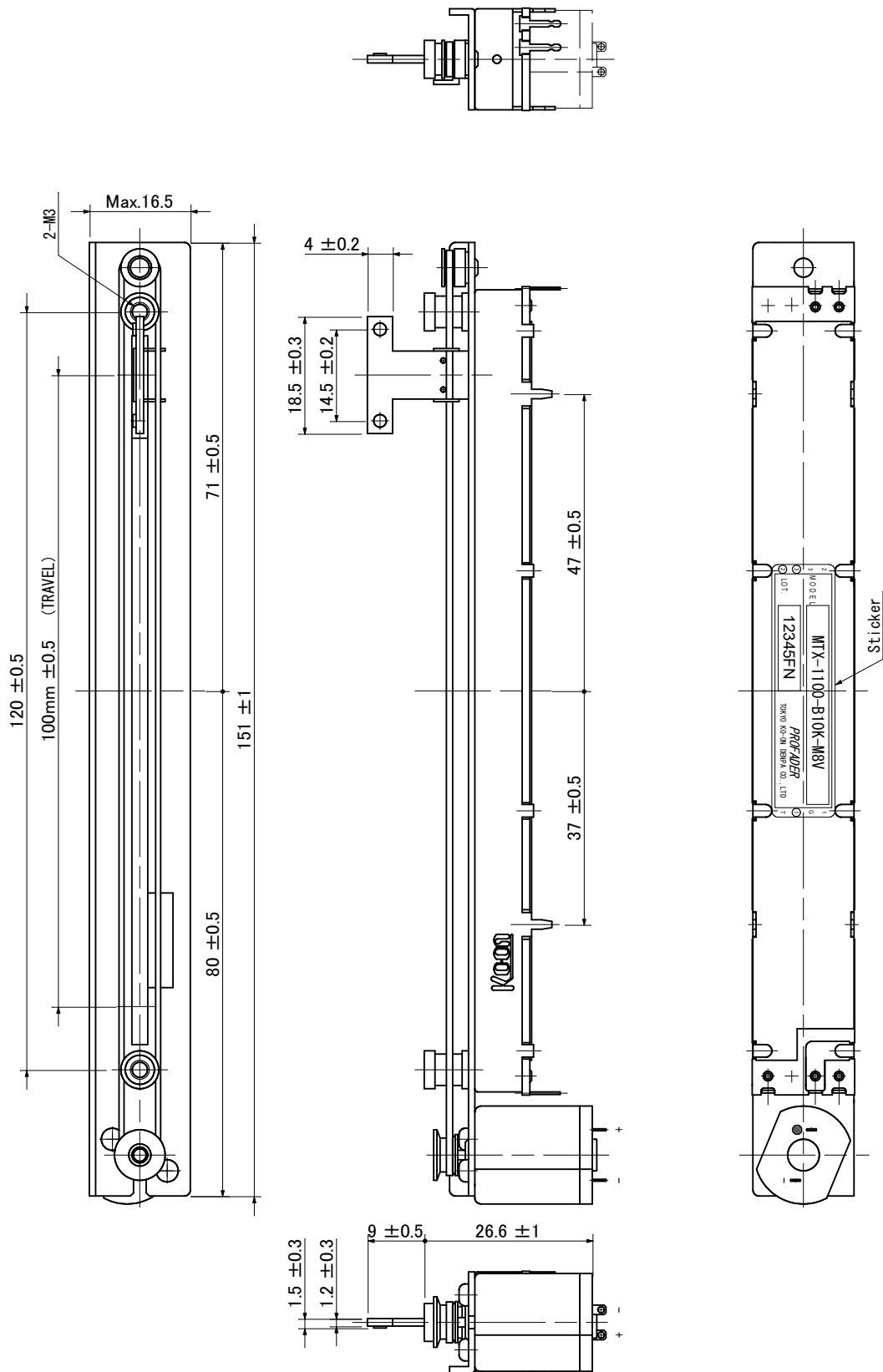

Dimensions - MTX-6100

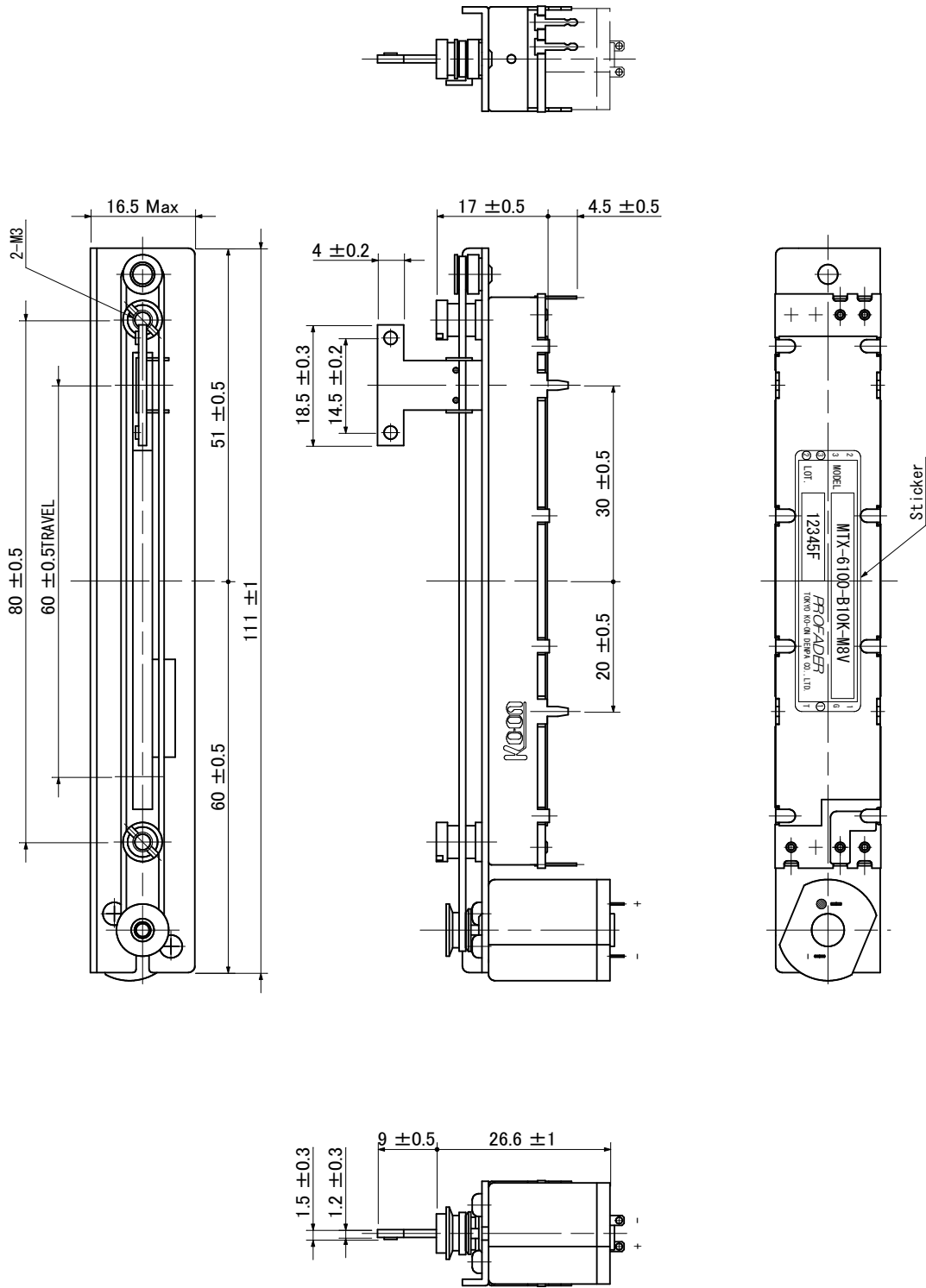

Dimensions

P.C Board Mounting hole detail (Viewed from mounting side)

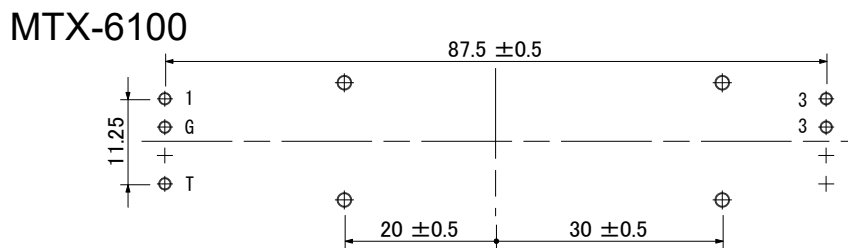
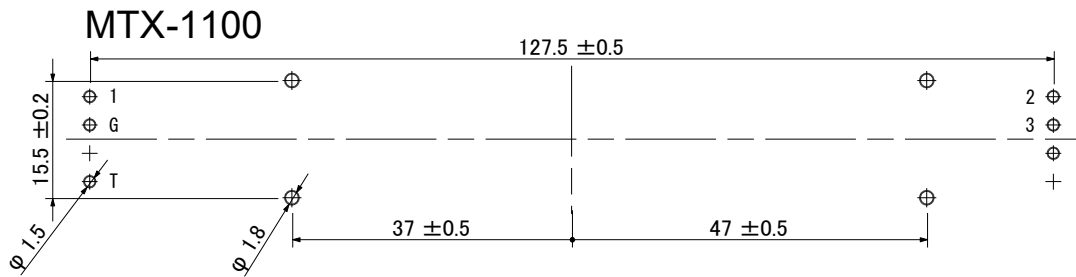

Panel cut out dimensions

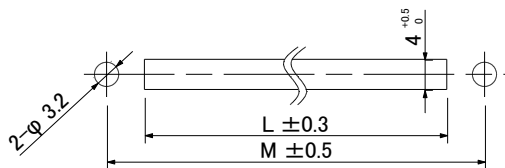

L=110mm M=120mm MTX-1100
L=70mm M=80mm MTX-6100

Terminal style

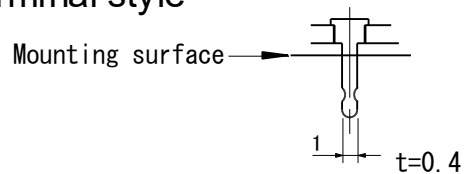

※Soldering of terminals to be made less than at 300 degreesC within 3sec max.

Terminations

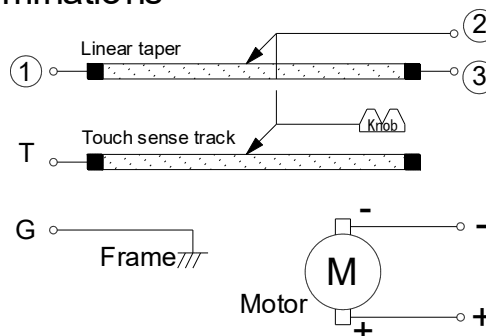

The products and their specifications are subject to change without notice.